



INSTALLATION MANUAL

Z-PC Line

Z-DAQ-PID

Analog, universal IN/OUT conversion and PID regulation with ModBUS RTU protocol based on RS485 serial interface

Chapter index	Page
1. Identification data	1
2. Preliminary warnings	2
3. Description and characteristics	2
3.1 Module description	
3.2 General characteristics and features	
4. Technical specifications	2
4.1 Input	
4.2 Output	
4.3 Connections	
4.4 1500 Vac insulations	
4.5 Power supply	
4.6 Module case	
4.7 Environmental conditions	
4.8 Standards	
5. Electrical connections	4
5.1 Safety measures before use	
5.2 RS485 and RS232 serial interface	
5.3 Connections	
5.4 Screw terminals connection	
6. Parameters for use	6
6.1 Setting parameters	
6.2 Communication parameters	
6.3 Dip-Switch tables	
6.4 Default configuration	
7. Most important RS485 registers	8
8. Signalling LEDs	8
9. Decommissioning and disposal	8
10. Purchase Order Code	8



3 operating modalities:

- ➔ **Conversion with PID regulation**
- ➔ **Conversion without PID regulation**
- ➔ **Manual (constant output operated by ModBUS)**



SENECA s.r.l.

Via Germania, 34 – 35127 – Z.I. CAMIN – PADOVA – ITALY

Tel. +39.049.8705355 – 8705359 Fax. +39.049.8706287

Internet site: www.seneca.it Technical assistance: support@seneca.it

Commercial reference: sales@seneca.it

SENECA® It is a registered International trademark. © 2010 All rights reserved.

This document is property of SENECA srl. Duplication and reproduction of its are forbidden (though partial), if not authorized. Contents of present documentation refers to products and technologies described in it. Though we strive for reach perfection continually, all technical data contained in this document may be modified or added due to technical and commercial needs; it's impossible to eliminate mismatches and discordances completely. Contents of present documentation is anyhow subjected to periodical revision. If you have any questions don't hesitate to contact our structure or to write us to e-mail addresses as above mentioned.

2. PRELIMINARY WARNINGS



Before carrying out any operation it's mandatory to read all the content of this user Manual. Only electrical-skilled technicians can use the module described in this user Manual.



Only the Manufacturer is authorized to repair the module or to replace damaged components.



No warranty is guaranteed in connection with faults resulting from improper use, from modifications or repairs carried out by Manufacturer-unauthorised personnel on the module, or if the content of this user Manual is not followed.

3. DESCRIPTION AND CHARACTERISTICS

3.1 MODULE DESCRIPTION

The Z-DAQ-PID module acquires 1 universal input signal and converts it to an analog format (with PID regulation), sent through 1 universal and isolated output signal.

3.2 GENERAL CHARACTERISTICS AND FEATURES

- 3 operating modalities: conversion with/without PID regulation, manual (constant output)
- Input: voltage type, current type, potentiometer type, thermocouple (TC) type, RTD (Resistance Temperature Detector) type, millivoltmeter type
- Output (analog or ON/OFF): voltage type, current type
- 1500 Vac insulation between: input, power supply, output and RS485-bus (figure 1)
- Configuration of the module (node) address and baud-rate by Dip-Switches
- It's possible to add/remove the module to/from RS485-bus without disconnecting the communication or power supply
- Switching automatically RS485 to RS232 or vice versa

4. TECHNICAL SPECIFICATIONS

4.1 INPUT

Number	1
Resolution	14 bits
Sampling time	Configurable between: 5 ms («Fast», no rejection), 16.66 ms (rejection to 60Hz) or 20 ms (rejection to 50Hz)
Filter	Configurable between: 0 (no filter is applied), from 1 (min) to 19 (max)
Response time	Sampling time + 6 ms
Voltage-type IN	Range is configurable: from 0 V to 10 V. Input impedance: 120 k Ω
Current-type IN (mA-passive module/mA-active module)	Scale range is configurable: from 0 mA to 20 mA. Internal shunt: 50 Ω . It's possible to power the sensor by: itself (mA-passive module) or module (mA-active module) using #7 screw terminal (max 25 mA to max 17 V, short-circuit protected)
Potentiometer-type IN	Scale range is configurable: from 1 k Ω to 100 k Ω (with parallel resistor R = 330 Ω to connect externally). Excitation current: 1 mA. Input impedance: > 5 M Ω . Automatic detection if a interruption occurs
Thermocouple-type IN (1)	For TC type: J, K, R, S, T, B, E, N. Input impedance: > 5 M Ω . Automatic detection if a TC interruption occurs
RTD-type IN (1)	For RTD type: PT100, PT500, PT1000, NI100. Resistance measure (for 2,3,4-wires connection) and wire-resistance measure (for 3,4-wires connection). Excitation current: 1.1 mA (PT100) and 0.11 mA (PT1000, PT500). Automatic detection if a wire or RTD interruption occurs

Millivoltmeter-type IN	Scale range is configurable between: -10 mV to 80 mV. Input impedance: > 5 MΩ
-------------------------------	---

Errors related to max measuring range	Accuracy	Thermal stability	Linearity error	EMI
Voltage or current-type input	0.1%	0.01%/°K	0.05%	<1% (2)
TC-type input: J, K, E, T, N	0.1%	0.01%/°K	0.2°C	<1% (2)
TC-type input: R, S	0.1%	0.01%/°K	0.5°C	<1% (2)
TC-type input: B (3)	0.1%	0.01%/°K	1.5°C	<1% (2)
Cold junction compensation (for TC-type input)	2°C between 0-50°C	/	/	/
POT-type input	0.1%	0.01%/°K	0.1%	<1%
RTD-type input (4)	0.1%	0.01%/°K	0.02%(if t>0°C) 0.05%(if t<0°C)	<1% (5)

(1)For the input scale ranges, see pag.7.

(2)Influence of wires resistance: 0.1 μV/Ω

(3)Output zero if t < 400°C

(4)For RTD type: PT100, PT500, PT1000, NI100. All the errors have to be calculated with reference to resistive value

(5)Influence of wires resistance: 0.005 %/Ω, max 20 Ω

4.2 OUTPUT

Number	1			
Resolution	14 bits			
Signal-amplitude limiting	The output signal can be amplitude-limited by a «output limiter»			
Voltage-type OUT	Configurable between: 0-5 V, 0-10 V (with minimum load resistance: 1 kΩ). Analog or ON/OFF signal type			
Current-type OUT (active or passive)	Configurable between: 0-20 mA, 4-20 mA (with maximum load resistance: 600 Ω). «Active current»=the output: already powered on, needs to be connected to the passive module; «passive current»=the output: powered off, needs to be connected to the active module. Analog or ON/OFF signal type			
Errors related to max measuring range	Accuracy	Thermal stability	Linearity error	EMI
Voltage-type OUT	0.1%	0.01%/°K	0.01%	< 1%
Current-type OUT (active or passive)	0.1%	0.01%/°K	0.01%	< 1%

4.3 CONNECTIONS

RS485 interface	IDC10 connector for DIN 46277 rail (back-side panel, figure 4).
RS232 interface	Jack stereo 3.5 mm connector:plugs into COMport(front-side panel)

4.4 1500 Vac INSULATIONS

The isolation voltage between:

- power supply
- analog input
- analog output
- RS485-bus

is **1500 Vac** (figure 1).

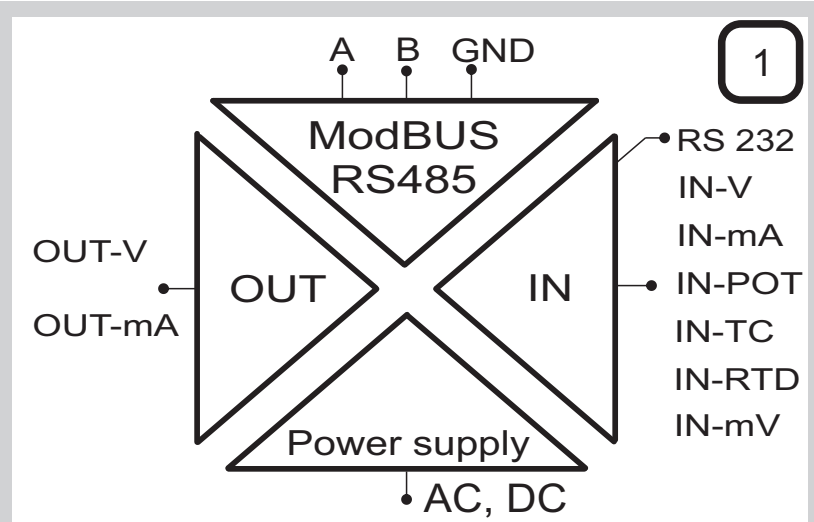

4.5 POWER SUPPLY

Supply voltage	10 – 40 Vdc or 19 – 28 Vac (50Hz - 60Hz) by: screw terminals 2,3 or IDC10 connector
Power consumption	Min: 0.5W; Max: 2W

The power supply transformer must comply with EN60742(Isolated transformers and safety transformers requirements).



Power on the module with < 40 Vdc or < 28 Vac voltage supply. These upper limits must not be exceeded to avoid serious damage to the module.

4.6 MODULE CASE

Case-type	PBT, black
Dimensions	Width W = 100 mm, Height H = 112 mm, Depth D = 17.5 mm
Terminal board	Removable 3-way screw terminals: pitch 5.08 mm, sections 2.5mm ²
Protection class	IP20 (International Protection)

4.7 ENVIRONMENTAL CONDITIONS

Operating temperature	-10°C ... +65°C
Humidity	30 - 90% to 40°C not condensing (during operation)
Max environment pollution degree	2
Storage temperature	-20°C ... +85°C

4.8 STANDARDS

The module complies with the following standards:

- EN 61000-6-4/2007 (electromagnetic emission, in industrial environment)
- EN 61000-6-2/2006 (electromagnetic immunity, in industrial environment)
- EN 61010-1/2001(safety). All electrical circuits must be isolated with double isolation from other circuits with dangerous voltage.

5. ELECTRICAL CONNECTIONS

5.1 SAFETY MEASURES BEFORE USE

The module is designed to be installed on DIN 46277 rail (figure 5) in vertical position.



It is forbidden to obstruct the module ventilation openings.
It is forbidden to install the module near heat-emitting devices.



Power off the module before connecting: RS232 serial interface, RS485 serial interface, input, output.

5.2 RS485 AND RS232 SERIAL INTERFACE

The module is designed to data interchange according to the ModBUS protocol rules, implemented by RS232 serial interface and RS485 serial interface. **The RS232 communication (with unchangeable parameters) has priority over the RS485 communication.**



The module has a Jack stereo connector in order to connect its to RS232-bus communication automatically (figure 2).

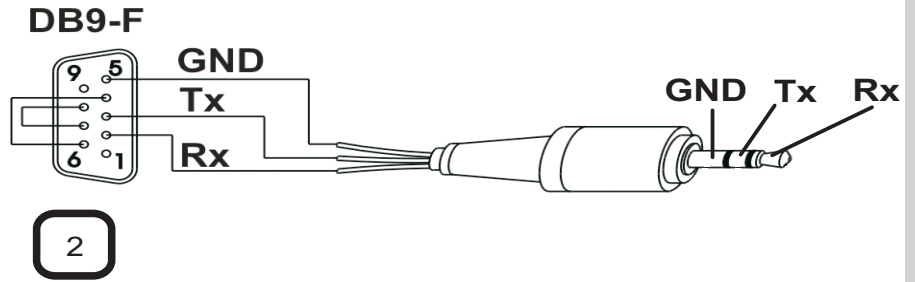

5.3 CONNECTIONS

To power the module and to connect it to the RS485-bus communication, use screw terminals placed in Z-PC-DINAL2-17,5 unit (figure 3) (Z-PC-DINAL2-17,5 unit can be locked on DIN 46277 rail).



Switch to «0» (OFF state) all the Dip-Switches (120 Ω Terminator) on DIN rail.

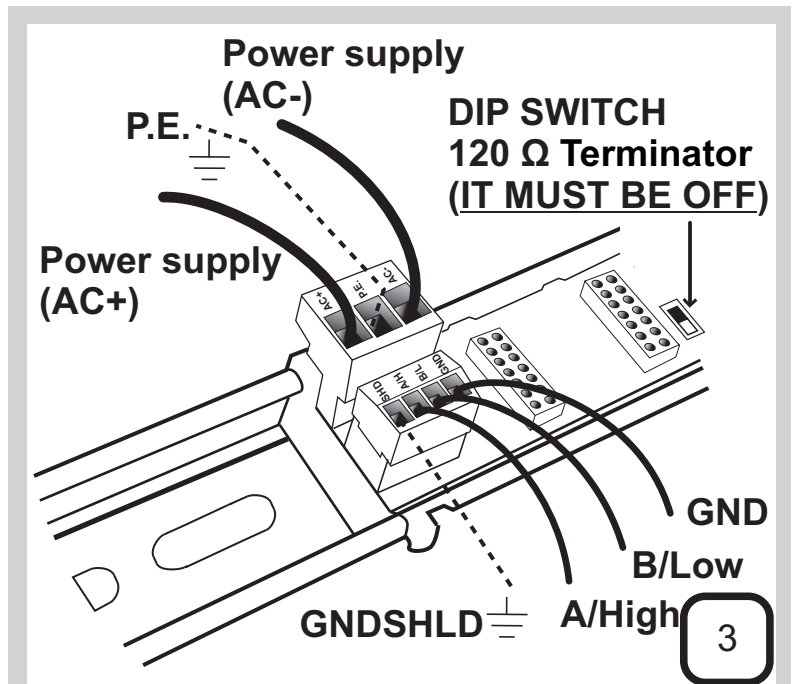
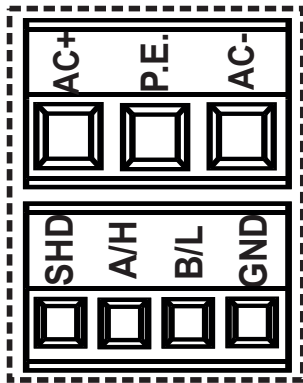

To power the module and to connect the module to RS485-bus, there is a connector (IDC10) in back-side panel (figure 4).

It's possible to lock on DIN 46277 rail the module, as shown in the following figure.

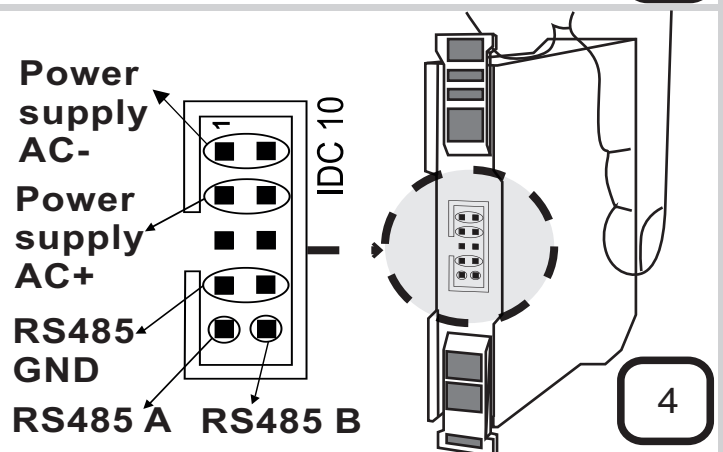

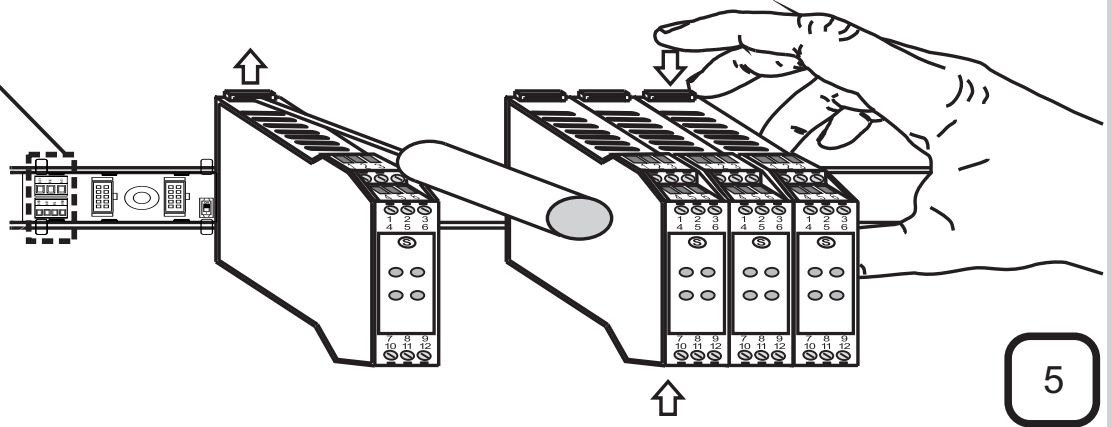
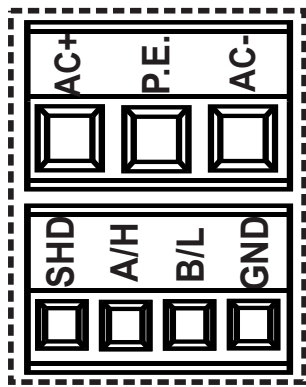

5

5.4 SCREW TERMINALS CONNECTION

INPUTS (SENSORS «S» CONNECTION)

Passive module

The sensor S supplies the loop (mA)

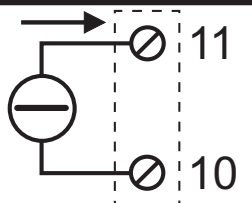

Voltage

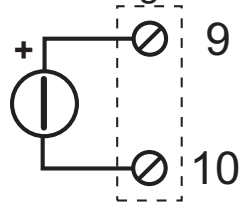

With $R=330\ \Omega$ (it needs to be added externally), $P=1k\Omega-100k\Omega$

Active module

The module supplies the loop (mA)

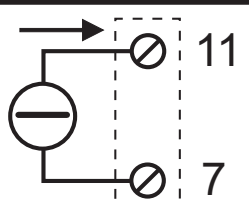

mV/TC

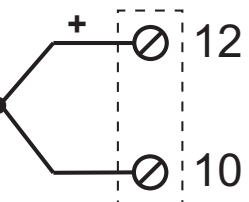

POT

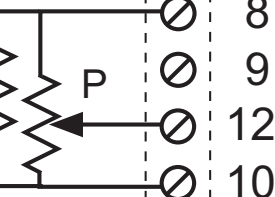

2-wire RTD

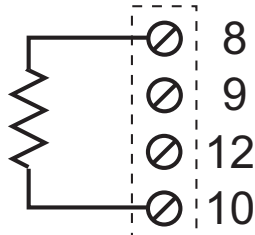

3-wire RTD

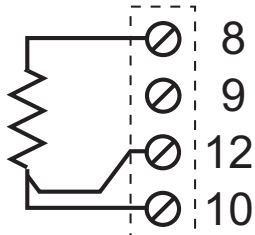

4-wire RTD

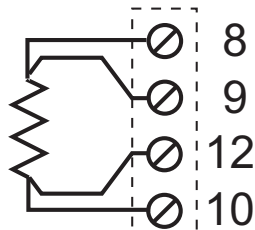

OUTPUTS

OUT voltage

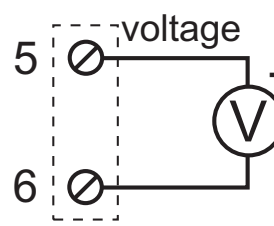

OUT current

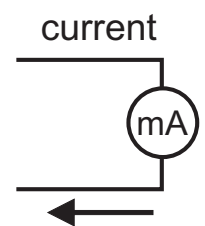

POWER SUPPLY

- 2 19.. 28 Vac
- 3 10..40 Vdc
- 2 W Max

There are 2 alternative modalities to power the module, by: screw terminals 2,3 or IDC10 connector

6

6. PARAMETERS FOR USE

It's possible to configure the module by two types of parameters: communication parameters and setting parameters. It's possible to know the module in details (with RS485 registers) to keep visiting the internet site www.seneca.it.

6.1 SETTING PARAMETERS

The setting parameters are: input type, input filter, input start/end scale, output type, output start/end scale, output limiter, electric-line frequency rejection, cold-junction compensation (for TC-type input), burn (for RTD or TC-type input), PID parameters. In particular, the input start/end scale values, for Thermocouple or RTD-type input, are shown in the following tables.

TC-type	Scale range	TC-type	Scale range
J	-210°C...1200°C	S	-50°C...1768°C
K	-200°C...1372°C	R	-50°C...1768°C
E	-200°C...1000°C	B	250°C...1820°C
N	-200°C...1300°C	T	-200°C...400°C
RTD-type	Scale range	RTD-type	Scale range
PT100	-210°C...650°C	PT1000	-200°C...210°C
PT500	-200°C...750°C	NI100	-60°C...250°C

6.2 COMMUNICATION PARAMETERS

The communication parameters of the module are: address, baud-rate, parity, delay of communication response. It's possible to configure these parameters by two alternative modalities: **by Dip-Switches**: the position of each Switch defines module (node) address and baud-rate, regardless of values stored in memory (EEPROM); **by memory (EEPROM)**: management of all communication parameters through the use of the configuration softwares.

 Memory (EEPROM) is used to store the module configuration and to keep stored it when the power is off.

 ZNET3 e Easy-Z-PC are the configuration softwares necessary to configure the module. It's possible to download these softwares to keep visiting the Internet site www.seneca.it.

6.3 DIP-SWITCH TABLES

 **Power off the module before configuring it by Dip-Switches to avoid electrostatic discharges.**

 In the following tables: box without circle means Dip-Switch=0 (OFF state); box with circle means Dip-Switch=1 (ON state).

BAUD-RATE (Dip-Switches: SW1)

1	2	Meaning
		Baud-rate=9600 Baud
	•	Baud-rate=19200 Baud
•		Baud-rate=38400 Baud
•	•	Baud-rate=57600 Baud

ADDRESS (Dip-Switches: SW1)

3	4	5	6	7	8	Meaning
						Address and Baud-Rate are acquired from memory (EEPROM)
					•	Address=1
				•		Address=2
				•	•	Address=3
			•			Address=4
					
•	•	•	•	•	•	Address=63

RS485-TERMINATOR (Dip-Switches: SW2)

1	2	Meaning
		RS485-terminator disabled
	•	RS485-terminator enabled

6.4 DEFAULT CONFIGURATION

The default configuration for the communication parameters is shown in the following table.

Communication	Data structure of register	Baud-rate	Address of node
RS232	8N1	2400(unchangeable)	1(unchangeable)
RS485	8N1	38400	1

To know the default configuration for the setting parameters, see User Manual (www.seneca.it).

7. MOST IMPORTANT RS485 REGISTERS

Name	Description	Address	Address
Set Point	Input set-point for the PID regulation: [%] with reference to the input scale range. Default=50% (floating point)	40022 (MSW)	40023 (LSW)
Electrical Input Value (Process value)	Input measure used for the PID regulation. Measure unit: [mV if voltage-type, μ A if current-type, %/100 if potentiometer-type, $^{\circ}$ C/10 if thermocouple or RTD-type, mV/100 if mV-meter-type]	/	40108 (word)
Electrical Output Value	Output measure. Measure unit: [mV, μ A]	/	40109 (word)
Error	Over range error. 0=there isn't it; 1=there is it	/	40069.5
Error	Input amplitude is less than start scale	/	40069.4
Error	Input amplitude is greater than end scale	/	40069.3
Error	Burn-out error (if input type is TC or RTD)	/	40069.2
Error	Thermocouple cold-junction error	/	40069.1
Error	Memory loss-of-data	/	40069.0

8. SIGNALLING LEDS

LED	LED status	Meaning
PWR	Constant light	The power is on
ERR	Blinking light	The module has at least one of the errors described in «RS485 Registers table»
RX	Constant light	Verify if the bus connection is corrected
	Blinking light	The module received a data-packet
TX	Blinking light	The module sent a data-packet

9. DECOMMISSIONING AND DISPOSAL



Disposal of Electrical & Electronic Equipment (Applicable throughout the European Union and other European countries with separate collections programs; see WEEE directive). This symbol, found on your product or on its packaging, indicates that this product should not be treated as household waste when you wish to dispose of it. Instead, it should be handed over to an applicable collection point for the recycling of electrical & electronic equipment. By ensuring this product is disposed of correctly, you will help prevent potential negative consequences to the environment and human health, which could otherwise be caused by inappropriate disposal of this product. The recycling of materials will help to conserve natural resources. For more detailed information about the recycling of the product, please contact your local city office, waste disposal service of the retail store where you purchased this product.

10. PURCHASE ORDER CODE

Order code	Description
Z-DAQ-PID	1-CH universal analog I/O Modbus module with PID control
Z-PC-DINAL2-17,5	DIN rail bus system - Z-PC line
Easy Z-DAQ-PID	Configuration software
PM001601	Programming cable